

rayTEC[®]



SPARTAN

MOUNTING & ACCESSORIES GUIDE

Bulkhead | Flood

This guide covers the different mounting options and accessories available for your SPARTAN Bulkhead and Flood* luminaires. Raytec provide a range of dedicated bracket solutions available to suit multiple wall, floor, ceiling, and pole mount configurations, along with bespoke lens options and protective kits.

We have separated the guide into four parts to help you identify your bracketry requirements.

1. Bulkhead & Flood – for use with both SPARTAN Bulkhead and SPARTAN Flood luminaires
2. Bulkhead Only – for use with SPARTAN Bulkhead luminaires
3. Flood Only – for use with SPARTAN Flood luminaires
4. Appendix – dimension sketches

Standard Mounting

SPARTAN Bulkhead and Flood luminaires are supplied together with standard bracketry solutions.

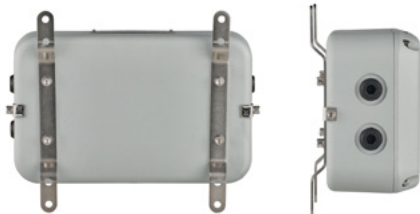

SPARTAN BL24 Bulkhead

Bulkhead

With standard bracketry, SPARTAN Bulkhead luminaires are designed to mount to any flat surface, both ceiling and wall. Provided in a pair, two low-profile stainless-steel ceiling/wall mounting brackets are supplied together with the unit and will screw easily to the back of the Bulkhead housing.



SPARTAN FL24 Flood

Flood

SPARTAN Flood is supplied with a stirrup bracket as standard. The bracket can be attached in the top or bottom position depending on the mounting application. A locking screw is provided to lock the luminaire at various angles, the unit can be mounted horizontally or vertically allowing the unit to point up/down or left/right.

*Excludes High Power Flood variants.

1. BULKHEAD & FLOOD OPTIONS



Sandblast Shield Kit

SPX-BKT-SB

The SPARTAN Sand Blast Shield Kit provides a clear polycarbonate front cover for your Flood or Bulkhead luminaire. It screws easily to the front to protect the lens from damage in sand and shot blasting applications.

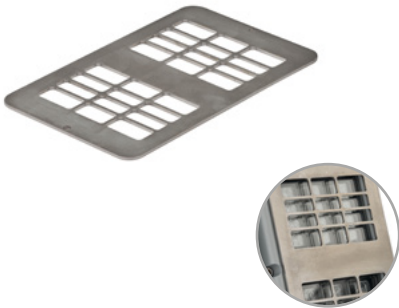

Front Guard

SPX-WG-FL12 (FL12 only)

SPX-WG-FL24 (FL24, FL48 (2 required) and Bulkhead)

The SPARTAN Front Guard is a stainless-steel grid plate. Already resistant to high impact, the front guard provides additional luminaire protection for environments of extreme mechanical impact. The grid plate can be fitted directly to the front of the luminaire, designed so as not to obstruct light output.



Protective Film

SPX-BKT-PF12 (FL12 only)

SPX-BKT-PF24 (FL24, FL48 (2 required) and Bulkhead)

SPARTAN Protective Film comes in a pack of 10. The films adhere to and protect the luminaire front lens within applications involving paint or with high dirt/dust levels.



Vario Diffuser

SPX-DIF12-XXXX (FL12 only)

SPX-DIF24-XXXX (FL24, FL48 (2 required) and Bulkhead)

(Select beam pattern below to replace 'XXXX')

Beam Patterns

120120, 3510, 6025, 8035, 12050

The VARIO Diffusers provide a range of different beam shapes and angles, using Raytec's unique beam shaping technology to produce a highly even and targeted elliptical spread of light – perfect for walkway applications or long/narrow spaces. With the outer luminaire cover removed, the diffuser – held within a mounting plate provided – is screwed to the inside of the front glass panel (replace the outer cover). The Vario Diffuser has 5 different angle options available including 120x120, 35x10, 60x25, 80x35 and 120x50.

All fixings provided.

2. BULKHEAD ONLY OPTIONS



Swivel Bracket Mounting Kit

SPX-BKT-SW
SPX-BKT-SWS (short)

The SPARTAN Swivel Bracket Mounting Kit is designed for ceiling and wall mounting of all SPARTAN Bulkhead luminaires. Typically mounted to the Flush Back Plate, 1 bracket is required for an individual Bulkhead unit. There is the facility to rotate the fitting through various angles to suit any application. The stainless-steel bracket provides lock-in holes every 30° and 45°. Shorter length variants are available providing part-rotation for restricted space applications.



Emergency Exit Sign Kit

SPX-BKT-EE1

The SPARTAN Emergency Exit Sign Kit is designed to convert the Bulkhead unit into an exit sign luminaire. Adhesive universal exit legends (with various options*) place onto a clear polycarbonate front panel with stainless steel mounts, which screws to the front of the luminaire. The Exit Sign Kit allows up to 48 different combinations during installation.

*Other designs available – contact Raytec for more information.

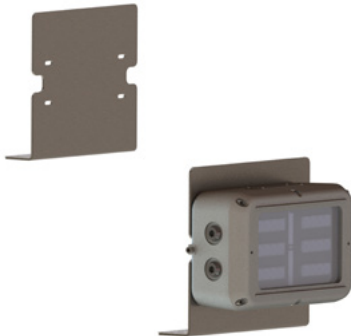

Floor Mount

SPX-BKT-BFL (Portrait)
SPX-BKT-BFLH (Landscape)

The SPARTAN Floor Mount is designed to mount SPARTAN Bulkhead to a flat floor surface. The dedicated stainless-steel bracket offers both portrait and landscape orientations.

All fixings provided.



Flush Rear Mount

SPX-BKT-BFRM

The SPARTAN Flush Rear Mount Plate is designed to mount SPARTAN Bulkhead luminaires flush to any flat wall surface.



Flush Back Plate

SPX-BKT-BFBP

The SPARTAN Flush Back Plate is a dedicated conversion bracket for the SPARTAN Bulkhead. It provides a stainless-steel mounting plate and suitable holes to accommodate the 'Swivel Mount Bracket' to the SPARTAN Bulkhead.



30° Bracket

SPX-BKT-BH30

The SPARTAN 30° bracket is designed to mount SPARTAN Bulkhead luminaires to any flat wall surface and provide a 30° fixed angle of illumination.



Pole Mount Bracket Kit

SPX-BKT-BPC28 (28mm)
SPX-BKT-BPC33 (33mm)
SPX-BKT-BPC42 (42mm)
SPX-BKT-BPC48 (48mm)
SPX-BKT-BPC60 (60mm)

The SPARTAN Pole Mount Bracket Kit includes a pair of dedicated brackets which easily screw to the back of the Bulkhead unit and combines with a pair of stainless-steel circular pole clamps, with adjustable side-bolts to open and clamp around a single pole. Kits to suit poles up to 60mm in diameter are available.



Spigot Mount Bracket

The SPARTAN Spigot Mount is designed to allow the Bulkhead unit to be used for pole mount applications. The Bulkhead unit will need to be ordered specifically for these applications as the main body has a different drilling pattern to allow the spigot to attach. Available in three sizes. Contact Raytec for part codes.

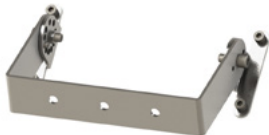

Stirrup Bracket

SPX-BKT-BLST

The SPARTAN Bulkhead Stirrup Bracket delivers maximum light where it is needed most. The dedicated bracket allows precise tilt and positioning of light into the required space.

3. FLOOD ONLY OPTIONS



Pole Mounting Kit

PBC1-SPX

The SPARTAN Pole Mounting Kit is designed to vertically pole mount SPARTAN Flood luminaires. Its dedicated stainless-steel plate provides a platform to attach the Flood U bracket to, and mounting clips attach and tighten the plate to your pole. Suitable for Flood luminaires up to size FL24.



Sunshield

SPX-BKT-SUN

The SPARTAN Sunshield is designed to mount to the FL24 luminaire to provide additional protection in high temperature applications. It shields the luminaire in situations where it may be subject to the effects of direct sunlight on the luminaire body.



180° Wall Mount Bracket

SPX-BKT-180

The SPARTAN 180° Wall Mount Bracket is designed to mount SPARTAN Flood luminaires to any flat wall surface and provide 180° horizontal rotation. Suitable for Flood luminaires up to size FL24.

All fixings provided.



Retention Cord Kit

SPX-BKT-SC500 (500mm)

SPX-BKT-SC1000 (1000mm)

SPX-BKT-SC1500 (1500mm)

The SPARTAN Retention Cord Kit is a stainless-steel cord and carabineer, which attaches to a retention bracket which can be easily screwed into the back of the luminaire. This provides an additional safety tether for height-critical applications. The kit is available in 500mm, 1000mm and 1500mm variants.



Magnetic Mounting Kit

SPX-BKT-MAG

The SPARTAN Magnetic Mounting Kit provides two magnetic discs which easily screw to the back of the fitting, and conveniently and securely attach it to any flat metal surface.

All fixings provided.

Can't find what you need?

We pride ourselves on flexibility and being able to meet the many demands of our customers. If you have a special requirement, and can't see a solution which is suitable, give us a call and chat to one of our experts to discuss how we can help.

1. BULKHEAD & FLOOD OPTIONS

Front Guard

SPX-WG-FL12 (FL12 only)

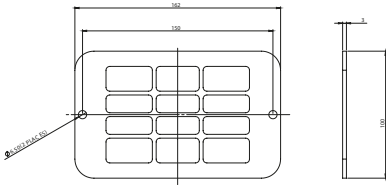

SPX-WG-FL24 (FL24, FL48
(2 required) and Bulkhead)

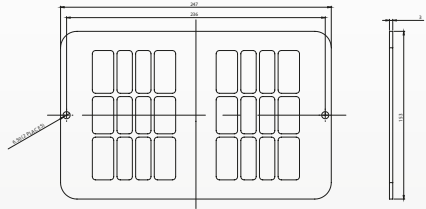

Vario Diffuser

SPX-DIF12-XXXX (FL12 only)

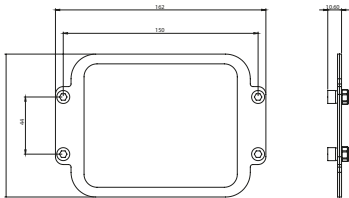

SPX-DIF24-XXXX (FL24, FL48
(2 required) and Bulkhead)

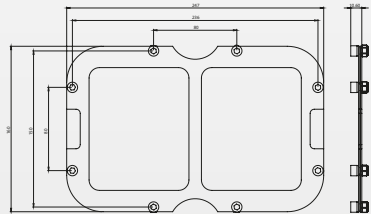

2. BULKHEAD ONLY OPTIONS

Swivel Bracket Mounting Kit

SPX-BKT-SW

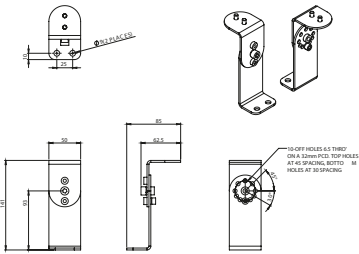

SPX-BKT-SWS (short)

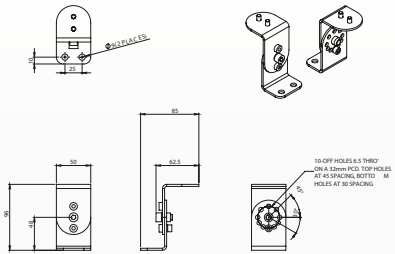

Floor Mount

SPX-BKT-BFL (Portrait)

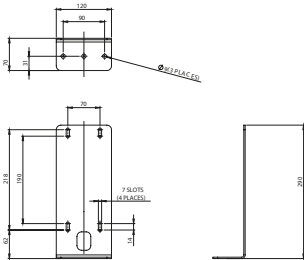

SPX-BKT-BFLH (Landscape)

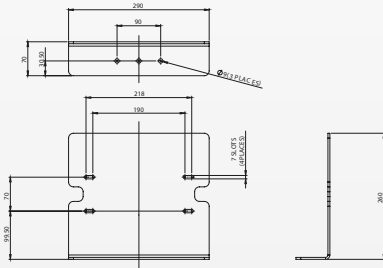

Emergency Exit Sign Kit

SPX-BKT-EE1

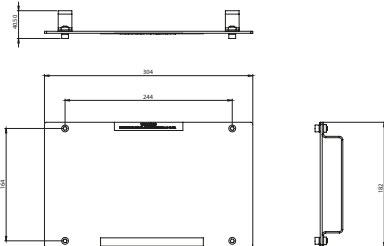

2. BULKHEAD ONLY OPTIONS

Flush Rear Mount

SPX-BKT-BFRM

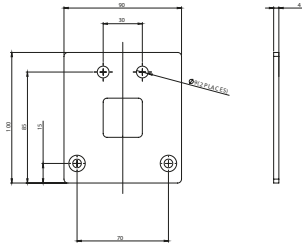

Flush Back Plate

SPX-BKT-BFBP

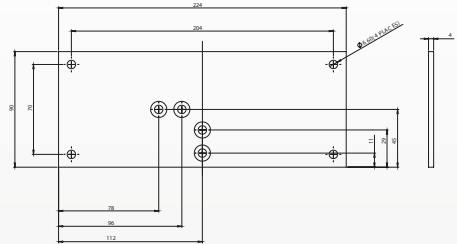

30° Bracket

SPX-BKT-BH30

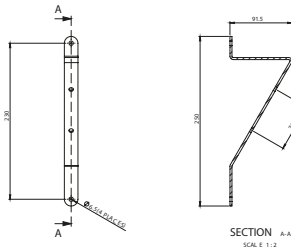

2. BULKHEAD ONLY OPTIONS

Pole Mount Bracket Kit

SPX-BKT-BPCXX

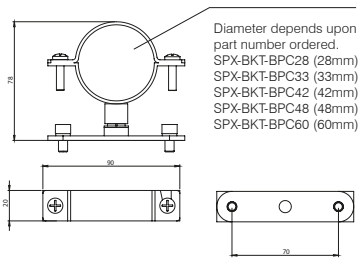

Stirrup Bracket

SPX-BKT-BLST

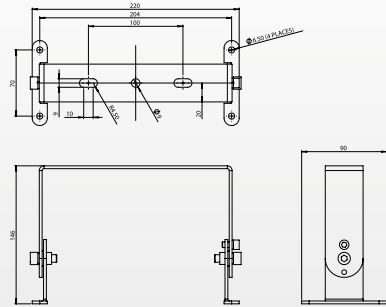

3. FLOOD ONLY OPTIONS

Pole Mounting Kit

PBC1-SPX

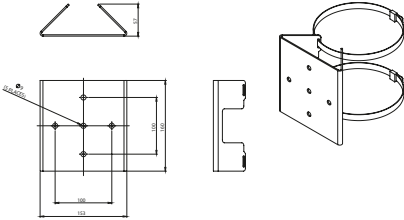

Sunshield

SPX-BKT-SUN

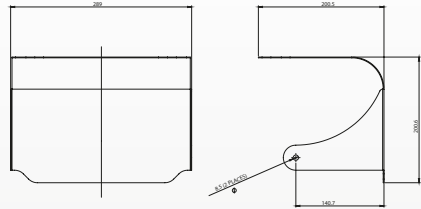

180° Wall Mount Bracket

SPX-BKT-180

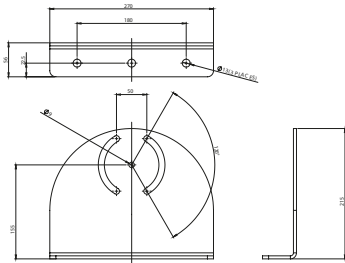



Hazardous Area LED Lighting with Worldwide Certification

Global HQ

T: +44 (0) 1670 520055
F: +44 (0) 1670 819760
hazsales@raytecled.com

Americas

T: +1 613 270 9990
T: +1 888 505 8335 (Toll Free)
ussales@raytecled.com

www.raytecled.com